

- 5A rating, change over circuit
- Snap action contacts mechanism with long life helicoidal spring
- Rock wipe and self-cleaning contact action
- Variety of actuators and contact arrangements
- Quick connect (faston), solder and PCB terminals
- Dimensions according to with DIN 41635 form B

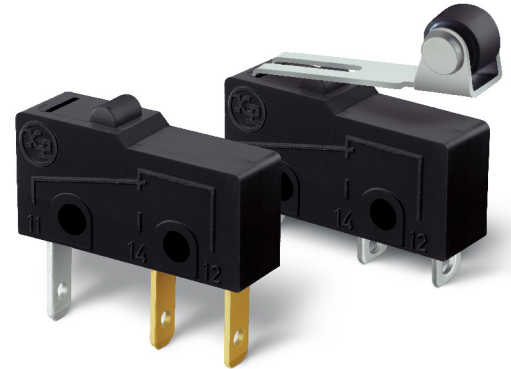

Rating

5A em 250Vac

Circuitry (IEC 60947-5-1)

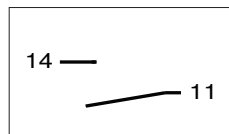

Form A (SPST-NO)

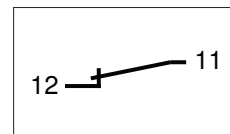

Form B (SPST-NC)

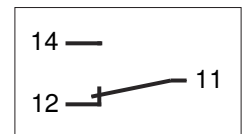

Form C (SPDT)

Specifications

Contact Resistance	50 mΩ maximum initial (at 1A 5Vdc)
Ambient Temperature	+85°C maximum
Degree of Protection	IP40 (IEC 60529)
Operating Speed	0,5 mm/s minimum to 1 m/s maximum (at Plunger)
Mechanical Life Expectancy	10.000.000 cycles
Electrical Life Expectancy	50.000 cycles (at 5A 250Vac)
Materials	Enclosure: Thermoplastic Polyamide
	Plunger: Thermoplastic Polyamide
	Actuators: Lever: Stainless Steel (types E, R and U) Nickel Plated Brass (types D, G and J)
	Roller: Thermoplastic Polyamide
	Terminals: Brass
Contacts: Silver Alloy	

Dimensions

Dimensions in mm

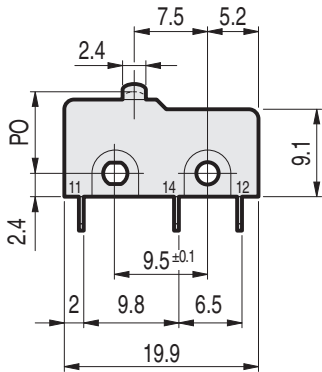

Standard model - Pin Plunger actuator
with Solder Terminal

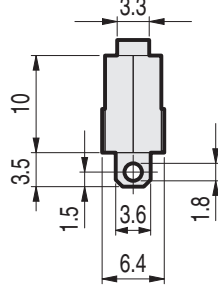

Quick Connect 0.110"
(Faston 2,8 X 0,5)
Terminal

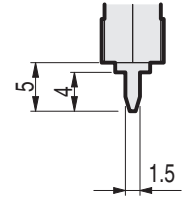
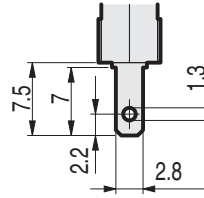

PCB Terminal

Switch with 3 terminals.
Standard contact configuration:
11 = Common (COM)
12 = Normally Closed (NC)
14 = Normally Open (NO)

Fixation

Dimensions in mm

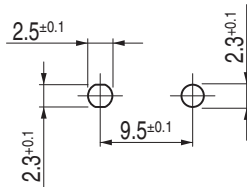

Mounting Holes

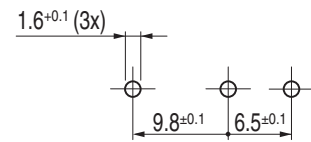

PCB Terminal
Mounting Holes

Integral Actuators

Dimensions in mm

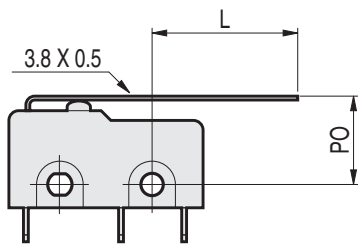

Hinge Lever (Type E)

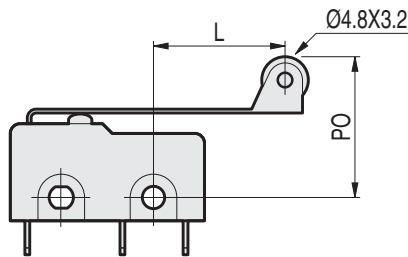

Roller Hinge Lever (Type R)

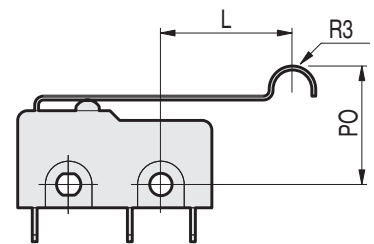

Roller Simulated Hinge Lever
(Type U)

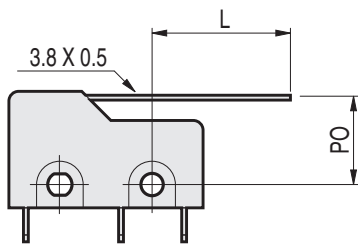

Hinge Lever (Type G)

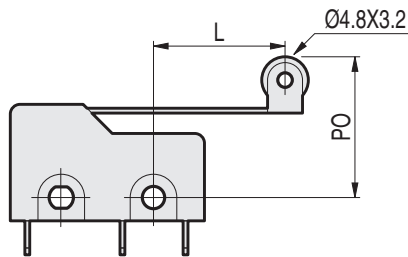

Roller Hinge Lever (Type J)

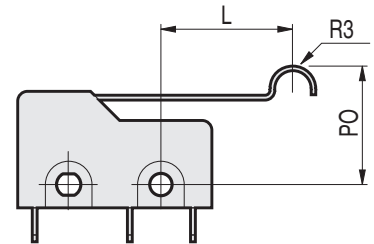

Roller Simulated Hinge Lever
(Type D)

Subject to change without prior notice



MM Series

Subminiature Switch

Ordering Information

M M 1 G 3 N S

Application	
Plunger Force	Code
100 gf	= MM2
200 gf	= MM1 ①

Terminals		
Type	Form	Code
Solder		= S ①
Quick Connect		= F
PCB		= I

Actuator		
Type		Code
Pin Plunger		= A ①
Short Hinge Lever		= E1 ①
		= E2
Hinge Lever		= E3
		= E4
Roller Short Hinge Lever		= R1 ①
Roller Hinge Lever		= R3
Simulated Roller Short Hinge Lever		= U1
Simulated Roller Hinge Lever		= U3
Short Hinge Lever		= G1
		= G2
Hinge Lever		= G3
		= G4
Roller Short Hinge Lever		= J1
		= J2
Roller Hinge Lever		= J3
		= J4
Simulated Roller Short Hinge Lever		= D1
		= D2
Simulated Roller Hinge Lever		= D3
		= D4

Contact Configuration		
NO + NC		= N ①
only NO (Normally Open)		= N1
only NC (Normally Closed)		= N2

Note:

The codes market with ① are standards versions.
The other (not marked) upon request.

Special Applications

Even though the products presented in this catalog for regular commercial use, we are able to develop "personalized" models for special applications. Contact us. Examples:

- UL marked products (File E212007)
- Enclosure UL94 V-0
- Other lengths, material and forms for the actuators.

Subject to change without prior notice







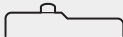

KAP COMPONENTES ELÉTRICOS Ltda.

Characteristics

Terminology: OF ... Operating Force
 OP ... Operating Position
 PT ... Pretravel

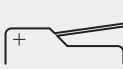
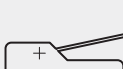
DT ... Differential Travel
 OT ... Overtravel
 L Actuator Length

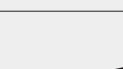
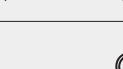
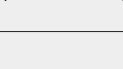
Actuator		OF (gf)		OP (mm)	PT max (mm)	DT max (mm)	OT min (mm)	L (mm)
		MM1	MM2					
	A	200	125	8.4 ± 0.4	0.8	0.15	0.4	-
	E1	56	34	8.9 ± 1.5	2.9	0.5	0.8	5.2 ± 0.4
	E2	43	26	8.9 ± 2.0	3,7	0.7	1.1	10.4 ± 0.4
	E3	37	23	8.9 ± 2.3	4.4	0.8	1.3	14.4 ± 0.4
	E4	33	20	8.9 ± 2.6	4.9	0.9	1.4	17.6 ± 0.4
	R1	55	34	14.4 ± 1.6	2.9	0.5	0.8	5.4 ± 0.6
	R3	39	24	14.4 ± 2.2	4.1	0.8	1.2	12.6 ± 0.6
	U1	52	33	11.9 ± 1.7	3.1	0.6	0.9	6.4 ± 0.6
	U3	38	24	11.9 ± 2.3	4.2	0.8	1.2	13.6 ± 0.6
	G1	53	33	8.9 ± 1.6	3.0	0.6	0.6	7.2 ± 0.5
	G3	39	24	8.9 ± 2.2	4.1	0.8	0.8	14.4 ± 0.5
	G2	21	13	8.9 ± 2.0	7.6	1.4	0.1	10.4 ± 0.5
	G4	15	10	8.9 ± 2.7	10.4	1.9	0.15	17.6 ± 0.5
	J1	58	36	14.4 ± 1.6	2.8	0.5	0.6	5.4 ± 0.6
	J3	42	26	14.4 ± 2.1	3.8	0.7	0.8	12.6 ± 0.6
	J2	23	14	14.4 ± 1.9	6.9	1.3	0.1	8.6 ± 0.6
	J4	16	10	14.4 ± 2.6	9.7	1.8	0.1	15.8 ± 0.6
	D1	55	34	11.9 ± 1.6	2.9	0.5	0.6	6.4 ± 0.6
	D3	40	25	11.9 ± 2.1	4.0	0.8	0.8	13.6 ± 0.6
	D2	22	14	11.9 ± 2.0	7.3	1.4	0.1	9.6 ± 0.6
	D4	16	10	11.9 ± 2.7	10.1	1.9	0.1	16.8 ± 0.6

Subject to change without prior notice